

# Countertop Measuring Guide

## General Rules for Measuring Your Countertop

### 1. How Much Overhang?

- Front of cabinet to front of counter  
Ideal = 1-1/2" underwrap, minimum 1-1/4"
- End of cabinet without appliance  
Standard 1" or more if preferred
- End of cabinet with appliance  
Enough overhang to cover cabinet with enough clearance for appliances to fit properly.

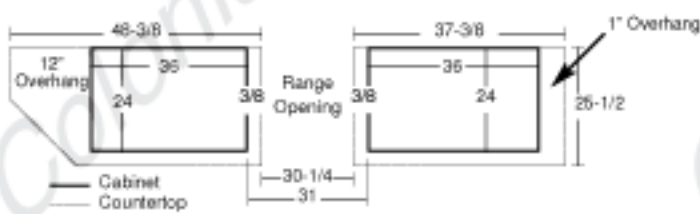

In this example, 3/8" overhang in range opening will allow for a 30-1/4" range opening.

### 2. Scribe

- For a professional-looking installation, countertops should be scribed or cut to fit to the wall.
- For example, if you put a straight edge against the wall, where your countertop will go, and found a space between the straight edge and the wall at any point. The measurement of that space would be the amount of scribe added to the length.

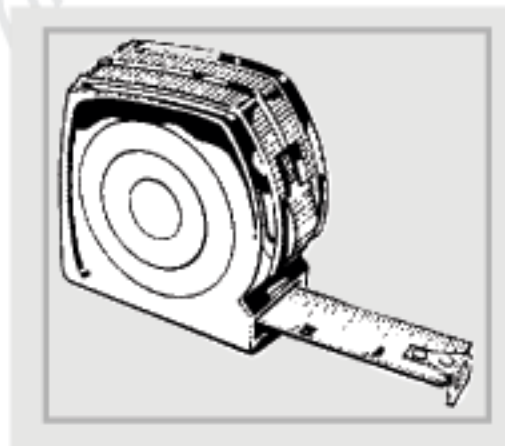

### 3. Check Walls For Square

- This can be done by putting straight edges against the walls in corners where your counter will be.
- From the inside of straightedge, measure 3' in one direction and 4' in the other direction. Make a mark on the straight edge.
- Measure between the two marks. Across (if square) should be 60". If not, make note of the size on the order. We will cut mitres accordingly.

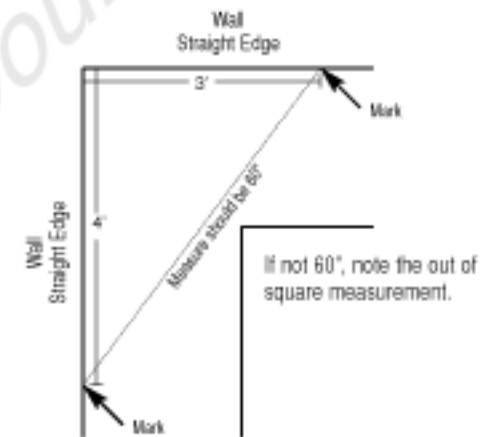

- \* All corners should be checked for square.
- \* Measuring for a 3-4-5 on walls without using straight edges is not always accurate.

### 4. Measuring Between Walls

- Whether or not you have a U-shape or a "straight" top between two walls, always measure between walls in more than one spot. See examples.

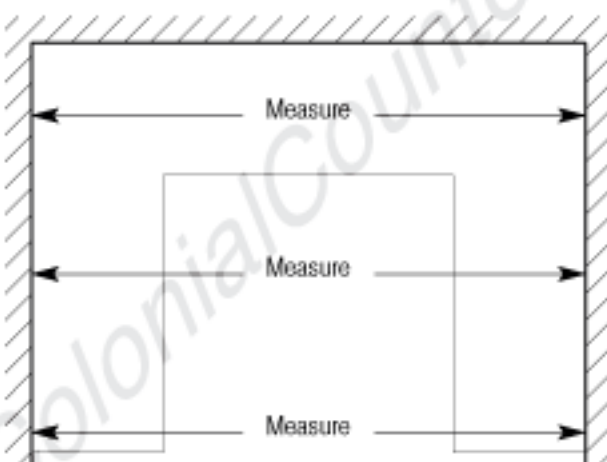
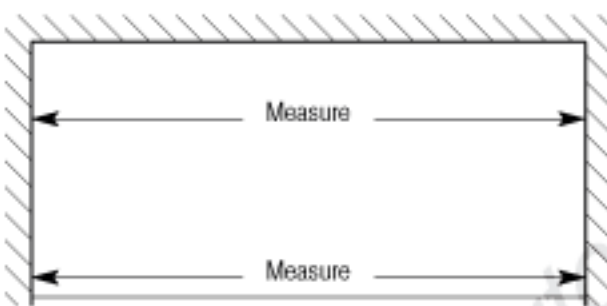

- On straight tops, if two measurements are different, determine which wall or walls are not square.

\* If you did a 3-4-5 measurement on a U-shape top and it didn't equal 60", the measures across will not be consistent.

### 5. Indicate End Finishes

- Print the letters shown in these examples:



- If you have a backsplash, where the end of the top goes against a wall, you usually have a side splash.



- Where the counter ends without a wall, or if it is against an appliance, laminate cap is used to finish top

\* If you are ordering bevel tops or wood edge tops, indicate where the appliances will be.



- If the wall stops shallower than the counter, you could have a combination of both. Indicate the depth of the wall.

### 6. Do You Require Build-Up?

- If counter comes down past the cabinet, you will not require build-up.

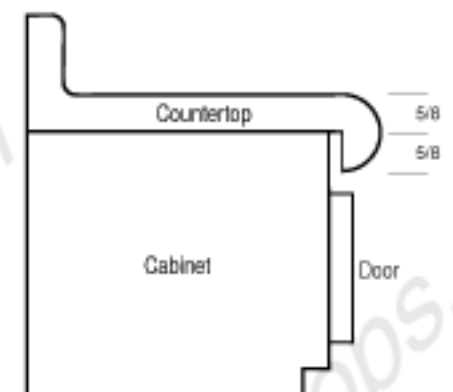

- Some cabinets (usually European style) require the top to sit right on top of the cabinet. Because the door comes almost right to the top of the cabinet, in this case you would require build-up.

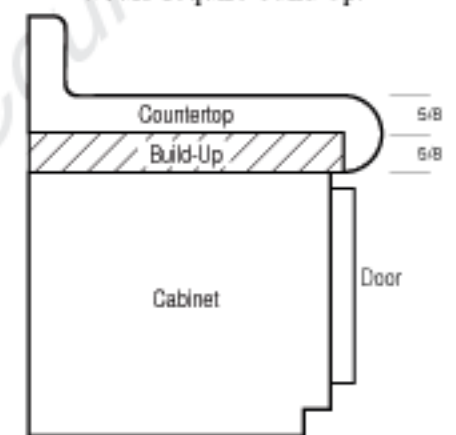

- Note on counter top orders whether you require build-up.

\* If you do not require build-up, please note how much overhang has been included on capped ends.

Sizes printed on countertop layout are the actual countertop sizes that will be cut.

These are only some general rules for basic countertop shapes and sizes.